

# Instruction for US launched V-2 no. 3



Due to the use of sharp knives, this kit is not suitable for young children.

Print the rocket on thin A4 cardboard - forexamble 100 - 160 gr./m<sup>2</sup>

To build the rocket you will need a flat cutting surface, a metal ruler, white glue, a sharp knife for cutting, a scissor and some toothpicks to apply glue to the parts. To strengthen some of the parts you will need some thicker grey cardboard. You will also need a small piece of thin metal wire.



Before glueing the parts together, it might be a good idea to paint all egdes of the parts with a yellow or black color pencil.

Remember to score all of the parts before folding them. I gently score them with a sharp knife. On my webpage (see below) - you will find links to websites with hints about building paper models.

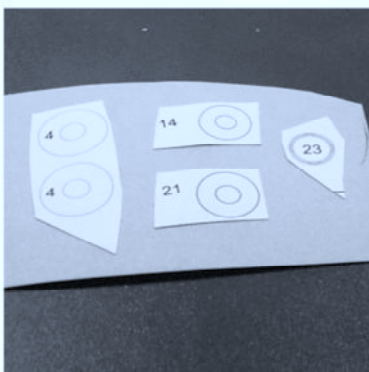

Glue the parts 4, 14, 21 and 23 to grey cardboard. Glue the connector 2, and

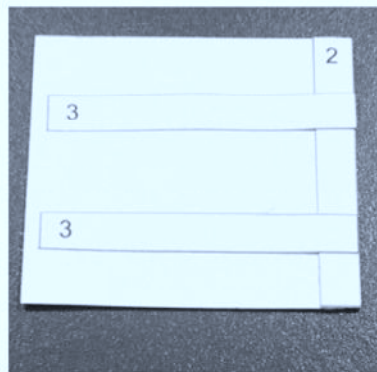

the strips 3 to the backside of part 1. Use the red markers as guidelines. When dry, roll 1

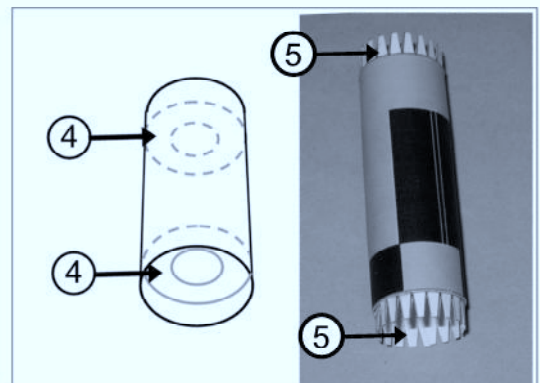

into a tube. Glue the discs 4 inside the top and the bottom of 1. Finally add the connectors 5 to each end of 1.

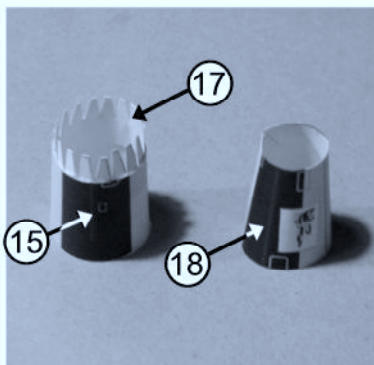

Glue 15 and 18 into cones using the connectors 16 and 19. Glue 17 to the bottom of 15.



Then glue 15 at the top of 18. Glue 20 to 21 as shown. Then glue 20 inside the rocket.

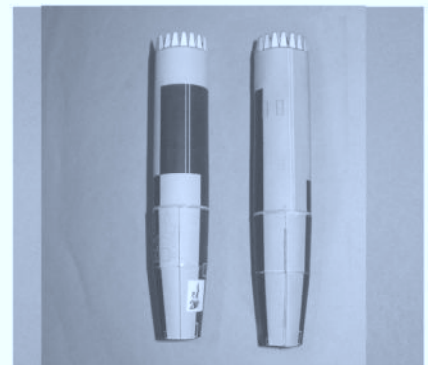
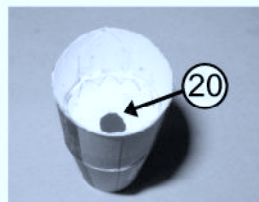
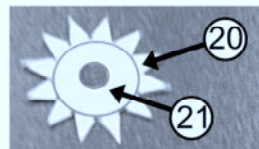

Then glue the lower part of the rocket to the main part as shown above.

# Instruction for US launched V-2 no. 3

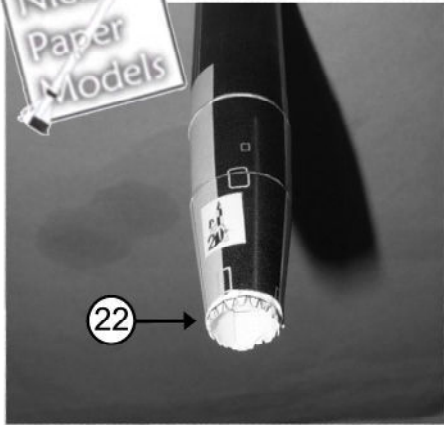

Glue the connector 22 inside the bottom of the rocket. Cutout 23. Roll 24 to a cone with the black

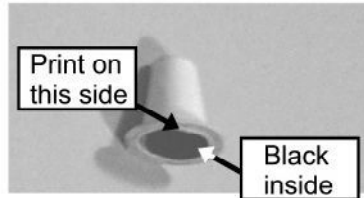
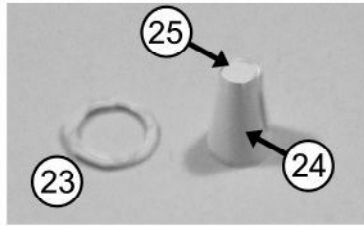

print on the inside. It is important, that 24 fits inside 23. Glue 25 at the top of 24 - and

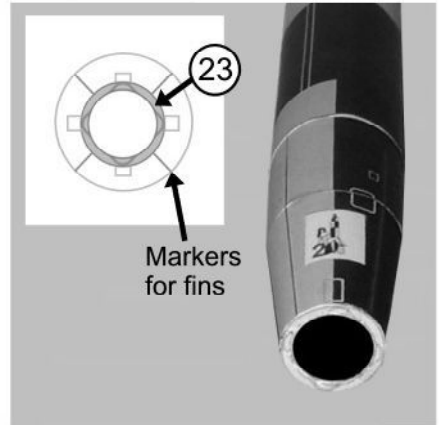

then glue 24 inside 23. At last glue the finished engine inside the bottom of the rocket.

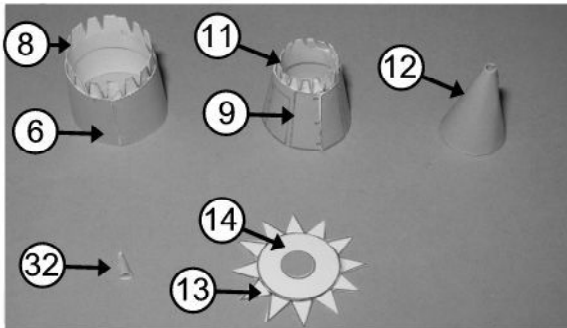

Glue 6, 9, 12 and 32 in to cones. Glue the connectors 8 and 11 in place. Glue 14 to 13. Then glue the nosecone together.

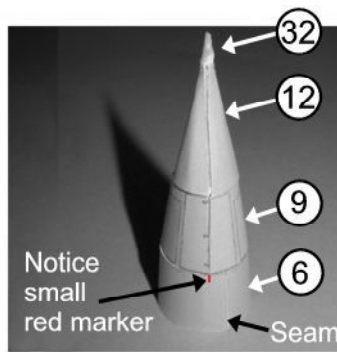

Then glue the nosecone together as shown above. Glue 14 into the nosecone.

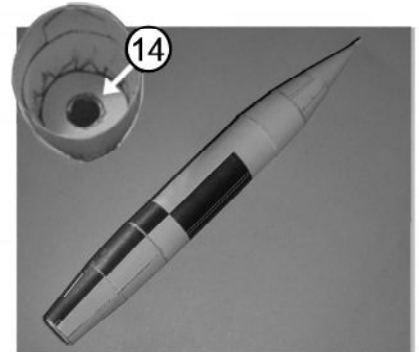

At last glue the nose to the main body of the rocket.

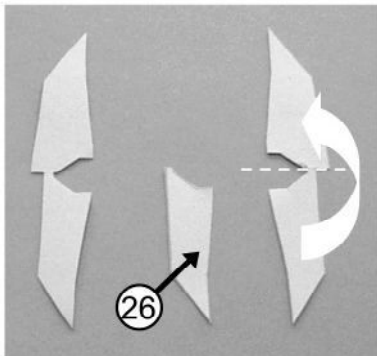

Each fin consists of 3 parts. Here they are shown with the backside up.

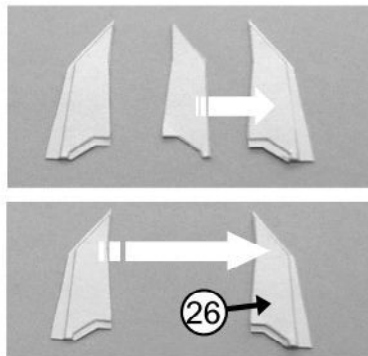

Fold and glue the lower part of the fin to the backside. Then glue 26 to one of the

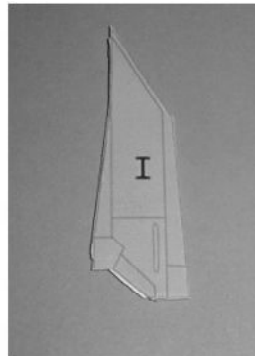

parts. Finally add glue in a thin layer to both halves. Carefull assemble the fin and press the edges together as shown.

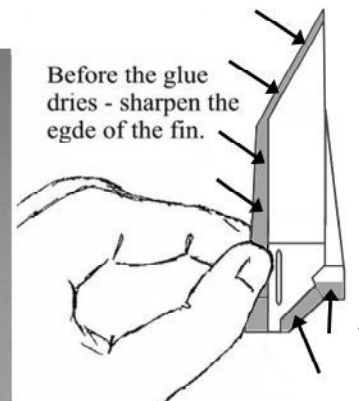

Before the glue dries - sharpen the edge of the fin.

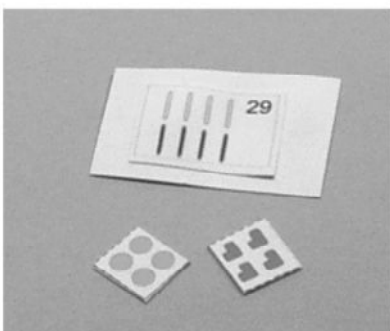

Glue 29 to another piece of thin cardboard.

Fold and glue 27 and 28.

Cut out and glue 29 to each side of the fin.

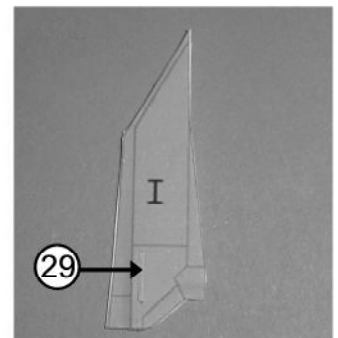

# Instruction for US launched V-2 no. 3

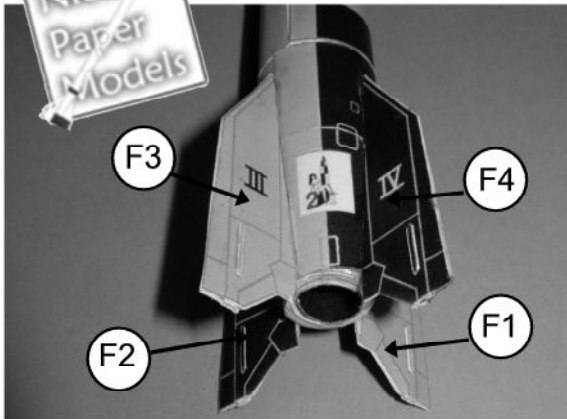

Glue the fins to the body using the blue guidelines. Make sure the rocket stands straight before the glue is absolutely dry.

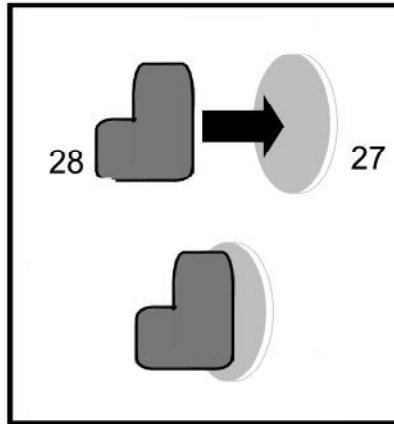

Make the 4 vanes. Cutout 27 and 28. Glue 28 to 27.

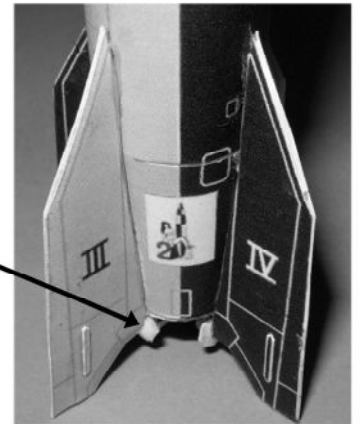

Glue the vanes in place.

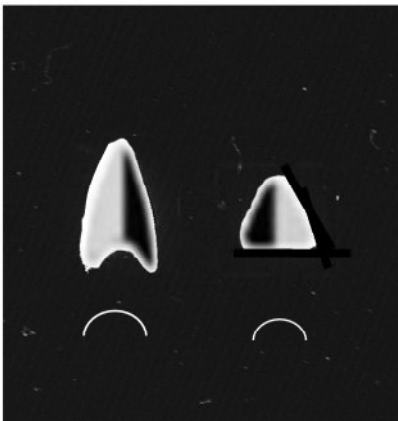

Use the tip of a toothpick to give 30 and 31 a semi-rounded shape.

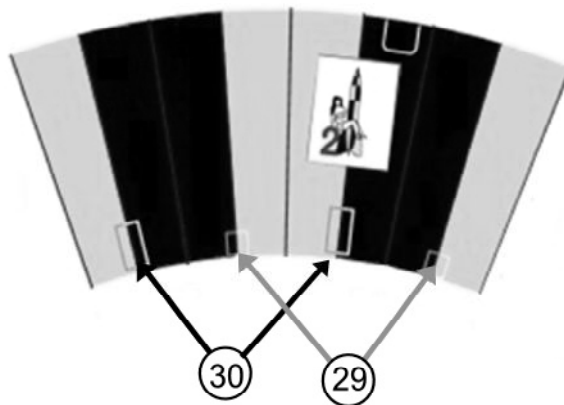

Glue 30 and 29 in place at the rockets bottom.



The stand for Hermes RV-A 10 can be used for the V-2. Glue the Do not glue the model to the stand.

There is a link for the stand at the V-2 models page at my website.